



— & —  
**SLIMLINE**  
—

DIRECT VENT GAS FIREPLACES

— **HEAT & GLO** —



CREATIVE  
VERSATILITY

# SLIMLINE

SlimLine fireplaces fit where others don't. Slender profiles with slim, flexible venting options offer an array of unique installation possibilities. Define any space with four sizes in decorative or heating models.

## RIGHT SIZE. RIGHT SPACE.

Find the right fire to fill your space. Select from 28, 32, 36 and 42-inch models. And keep creative installation options in mind. Corners. Flush. Or Raised. In dens, bedrooms and everywhere in between.

## YOUR FIRE. YOUR FLAMES.

We created the fire. Now it's yours to enjoy. Select a decorative or heater-rated model to savor the looks, or the warmth of your SlimLine.

## YOUR STYLE. ONLY YOURS.

Create your own unique style. From front styles to finishes, mantels and controls.



LEFT: SL-550TRS shown with halston front in black and kenwood mantel

BOTTOM RIGHT: SL-550TR shown with chateau front in black

COVER: SL-750TRS



*SL-550TR shown with folio front in black and custom surround.*

**SPACE. SIZE. SELECT.**

Consider heat output, room dimensions and venting in your space. And then select a 28, 32, 36 or 42-inch model.

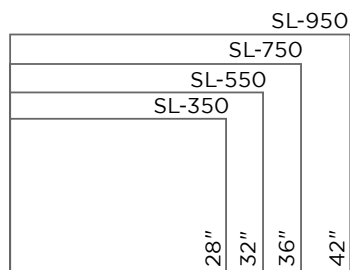

**CHOOSE YOUR MODEL**

**TRS MODELS:** Enhanced flames and greater heat output. With an upgraded ceramic burner, brick interior and detailed log set. Available in SL-350TRS, SL-550TRS and SL-750TRS models.

**TR MODELS:** Full flames, authentic log sets and moderate, efficient heat production. Available in SL-550TR, SL-750TR and SL-950TR models.

FEATURES	SL-350TRS	SL-550TR	SL-550TRS	SL-750TR	SL-750TRS	SL-950TR
AFUE Rated	•		•		•	
Heater Rated		•		•		•
Brick Refractory Kit	optional	optional	standard	optional	standard	optional
Sealed Combustion Chamber	•	•	•	•	•	•
Selection of Decorative Fronts	•	•	•	•	•	•
Optional Fan Kit	•	•	•	•	•	•
Optional Remote Control/Wall Switch	•	•	•	•	•	•
Ceramic Gas Logs	4	5	5	5	5	5
Limited Lifetime Warranty	•	•	•	•	•	•
Top and Rear Direct Vent	•	•	•	•	•	•
IntelliFire™ Ignition System	•	•	•	•	•	•
Adjustable Valve	•	•	•	•	•	•
Gas Flex Connection	•	•	•	•	•	•
Ceramic Glass	•		•		•	
Tempered Glass		•		•		•

**CHOOSE YOUR FRONT**

Four fronts are available in black, graphite and new bronze.



**FOLIO**  
(Inside Fit)



**CHATEAU**



**HALSTON**



**CLEAN FACE**  
(Inside Fit)

**FINISHES**

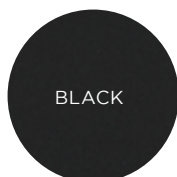



**SELECT A MANTEL SYSTEM**

Complete your SlimLine with distinctive style. A variety of mantel systems can transform your space. Select from a range of styles. Visit [heatnglo.com](http://heatnglo.com) for more options and additional information on mantel systems, shelves and stone surrounds.



PORTICO







KENWOOD (W/BASE)



SONOMA

**TAKE CONTROL**

Add an optional wall switch or remote for enhanced convenience.

		Wall Switch or Remote Control	On/ Off	Fan Speed	Flame High/Low	Pilot Activation	AUX Function	Temp Readout	Thermostat Mode	Timer Mode	7-day Programmable	Battery Strength Indicator	Auto Battery Backup
WSK200-HNG		Wall	•	•		•						•	•
WSK-MLT		Wall	•	•	•	•	•	•	•				
SMART-STAT-HNG		Remote	•					•	•	•			
RCT-MLT-HNG		Remote	•	•	•			•	•	•			
SMARTBATTHNG-B		Remote	•					•	•	•			

**SLIMLINE TECHNOLOGIES**



**INTELLIFIRE IGNITION SYSTEM**

The IntelliFire™ Ignition System (IPI) is an advanced intermittent pilot ignition system. IPI constantly monitors ignition, ensures safe functioning and conserves up to \$10/month in energy costs.



**DIRECT VENT TECHNOLOGY**

Direct Vent fireplaces remove 100% of combustion exhaust and odors outside of the home. These sealed fireplaces provide optimal heat, conserve energy and ensure clean, safe indoor air quality.

SLIMLINE SPECIFICATIONS

MODEL	FRONT WIDTH		BACK WIDTH		HEIGHT		DEPTH		VIEWING AREA	BTU/HOUR INPUT (NG)
	ACTUAL	FRAMING	ACTUAL	FRAMING	ACTUAL	FRAMING	ACTUAL	FRAMING		
SL-350TRS	33 [838]	34 [864]	22-3/4 [578]	34 [864]	32-3/8 [822]	32-3/4 [832]	16-1/4 [413]	16-1/4 [413]	24-3/16 X 16 [614 x 406]	14,400-20,500
SL-550TR & TRS	36 [913]	37 [940]	25-3/4 [653]	37 [940]	34-3/8 [873]	34-3/4 [882]	16-5/16 [415]	16-1/4 [413]	27-3/16 X 18-1/16 [691 x 459]	18,200-27,300 (TRS) 15,000-21,000 (TR)
SL-750TR & TRS	41 [1041]	42 [1067]	30-3/4 [781]	42 [1067]	37-7/8 [962]	38-1/4 [971]	16-5/16 [415]	16-1/4 [413]	32-1/16 X 21-1/2 [814 x 546]	20,200-30,800 (TRS) 16,900-24,300 (TR)
SL-950TR	48 [1218]	49 [1245]	37-3/4 [959]	49 [1245]	41-7/8 [1063]	42-1/4 [1073]	16-5/16 [415]	16-1/4 [413]	39-1/16 X 23-9/16 [992 x 599]	20,900-30,400

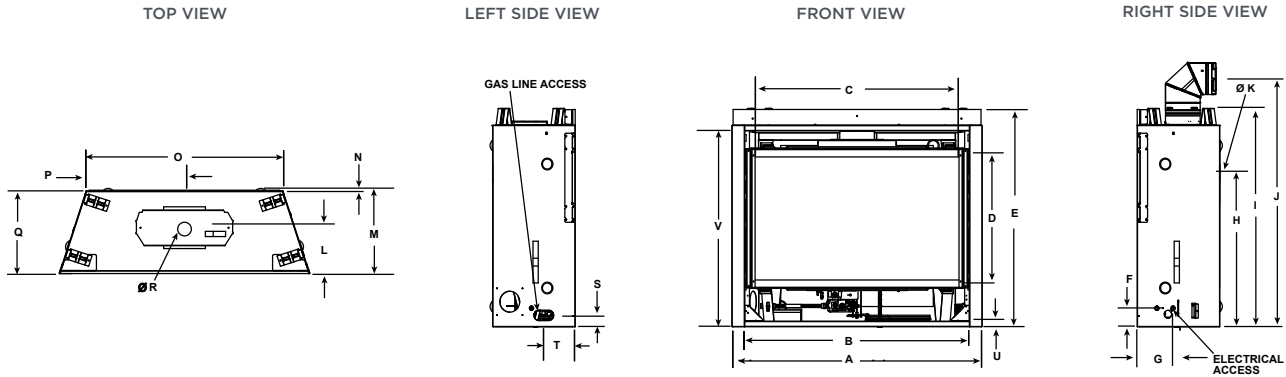

MODEL	A	B	C	D	E	F	G	H	I	J	K	L	M	N	O	P	Q	R	S	T	U	V
SL-350TRS	33 [838]	28-1/8 [714]	24-1/8 [613]	16 [406]	32-1/8 [816]	3-1/2 [90]	6-7/8 [175]	21-3/8 [543]	32-3/8 [822]	34-1/2 [877]	8 [203]	8-3/4 [222]	16-1/4 [413]	1/2 [13]	22-3/4 [578]	11-3/8 [289]	15-7/8 [403]	6-5/8 [168]	2-1/8 [54]	6 [153]	1 [25]	28 [712]
SL-550TR & TRS	36 [913]	31-1/8 [791]	27-3/16 [691]	18-1/16 [459]	34-1/16 [865]	3-9/16 [90]	6-7/8 [175]	23-3/8 [593]	34-3/8 [873]	36-7/16 [926]	8 [203]	8-13/16 [223]	16-5/16 [414]	1/2 [13]	25-3/4 [653]	12-7/8 [326]	15-7/8 [403]	6-5/8 [168]	2-3/16 [55]	6 [152]	1 [25]	30-1/16 [764]
SL-750TR & TRS	41 [1041]	36-1/8 [917]	32-1/16 [815]	21-1/2 [547]	37-5/8 [956]	3-9/16 [90]	6-7/8 [175]	26-7/8 [683]	37-7/8 [962]	39-15/16 [1015]	8 [203]	8-13/16 [223]	16-5/16 [414]	1/2 [13]	30-3/4 [781]	15-3/8 [391]	15-7/8 [403]	6-5/8 [168]	2-3/16 [55]	6 [153]	1 [25]	33-9/16 [853]
SL-950TR	48 [1218]	43 [1092]	39-1/16 [993]	23-9/16 [599]	41-9/16 [1056]	3-9/16 [90]	6-7/8 [175]	30-7/8 [785]	41-7/8 [1063]	43-15/16 [1117]	8 [203]	8-13/16 [223]	16-5/16 [414]	1/2 [13]	37-3/4 [959]	18-7/8 [478]	15-11/16 [399]	6-5/8 [168]	2-3/16 [56]	6 [153w]	1 [25]	37-9/16 [955]

Dimensions above are in inches and millimeters. Product information is not complete and is subject to change without notice. Product installation must adhere strictly to instructions shipped with product. We recommend measuring individual units at installation. Assumes the use of 1/2" sheetrock. NOTE: Combustible material should not cover the face. Make sure you do NOT cover the decorative door opening. Refer to installation manual for detailed specifications on installing this product. Heat & Glo reserves the right to update units periodically. The flame and ember appearance may vary based on the type of fuel burned and the venting configuration used. Actual product appearance, including flame, may differ from product images.

U.S. EFFICIENCIES

**Steady State** - Since most homeowners use their fireplaces for an extended time while they are in the room, Steady State measures how efficiently your fireplace converts fuel to heat once it is warmed up and running in a "steady state".

**AFUE** - AFUE rating is more typically used with appliances, like your furnace, that continually cycle on and off to maintain a constant temperature.

RATING	SL-350TRS-IP1	SL-550TR-IP1-E	SL-550TRS-IP1-E	SL-750TR-IP1-E	SL-750TRS-IP1-E	SL-950TR-IP1-E
STEADY STATE	77% (NG)	75% (NG)	75% (NG)	74% (NG)	78% (NG)	77% (NG)
AFUE	55%	49%	61%	46%	61%	59%

CANADA EFFICIENCIES

**EnerGuide (CSA P.4.1-02)** - EnerGuide is a rating used in Canada to measure annual fireplace efficiency.



RATING	SL-350TRS-IP1	SL-550TR-IP1-E	SL-550TRS-IP1-E	SL-750TR-IP1-E	SL-750TRS-IP1-E	SL-950TR-IP1-E
ENERGUIDE (CSA P.4.1-02)	58% (NG)	51% (NG)	65% (NG)	56% (NG)	64% (NG)	61% (NG)

For complete information on this model,  
please contact us at:

# HEAT & GLO®

No one builds a better fire

Web: [heatnglo.com](http://heatnglo.com)  
Phone: (888) 427-3973 (952) 985-6000  
E-mail: [info@heatnglo.com](mailto:info@heatnglo.com)

 [facebook.com/HeatandGlo](https://facebook.com/HeatandGlo)  
 [twitter.com/HeatandGlo](https://twitter.com/HeatandGlo)  
 [youtube.com/HeatandGlo](https://youtube.com/HeatandGlo)

HNG-1069U-0415

## LIMITED LIFETIME WARRANTY\*

The strongest in the industry, Heat & Glo® provides a limited lifetime warranty on the most important aspects: firebox and heat exchanger.

\*For full warranty details, go to [www.heatnglo.com](http://www.heatnglo.com).

Fireplace glass and other surfaces get extremely HOT and can cause severe burns if touched. Do not remove the protective safety screen from the front of the glass. Keep a safe distance away. To learn more visit [www.heatnglo.com/fireplacesafety](http://www.heatnglo.com/fireplacesafety)

